

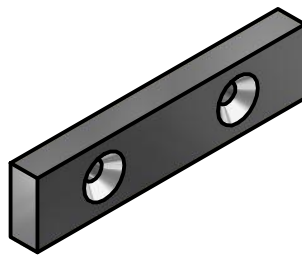

A-A (2 : 1)

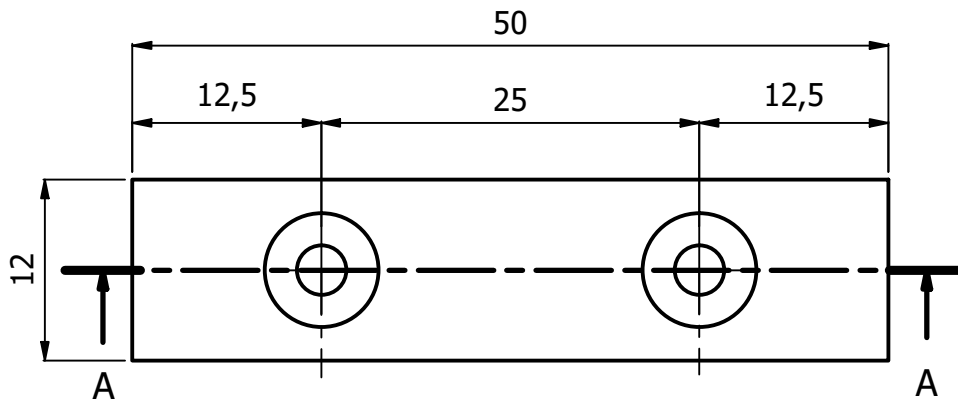
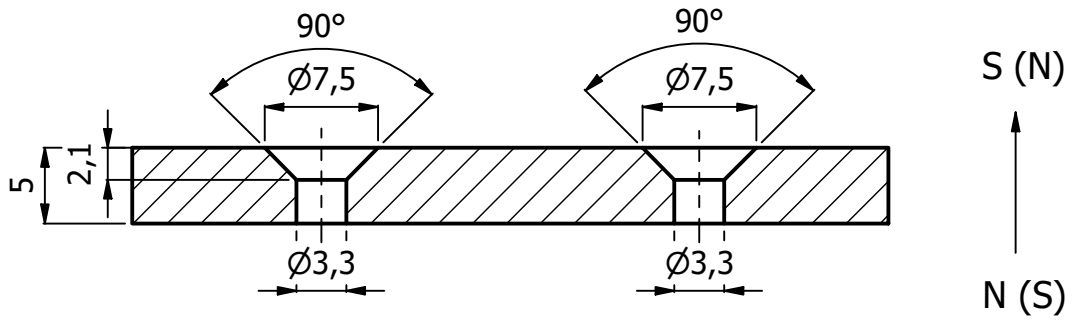

All measures are in millimeters (mm)

Author M.D.	Date 17/02/2020	Type	Surface Treatment Nickel coated	Material Neodymium	Measures tolerance: +/- 0.05 mm
			Description 2 countersink holes magnet - axially magnetized (N+S pole)		
			Code NQ03.35NI00.50123	Scale 2 : 1	Format A4
Via F. Comelli 39 33034 Fagagna UD - Tel. 0432 801675					